

Crossword and Word Search

Preparing to Build the Tabernacle

Across:

- 2. A spicy or aromatic vegetable substance.
- 4. A portable, tentlike structure.
- 7. Polished gemstones.
- 10. Anything offered as a gift.

Down:

- 1. The substance of which something is made.
- 3. A white, malleable, metal material.
- 5. A metal alloy containing copper and zinc.
- 6. Combustible liquid used to light lamps.
- 8. The treated hides of a animals.
- 9. The fibrous substance that a tree is composed of.
- 11. A precious yellow metallic element, not subject to corrosion.

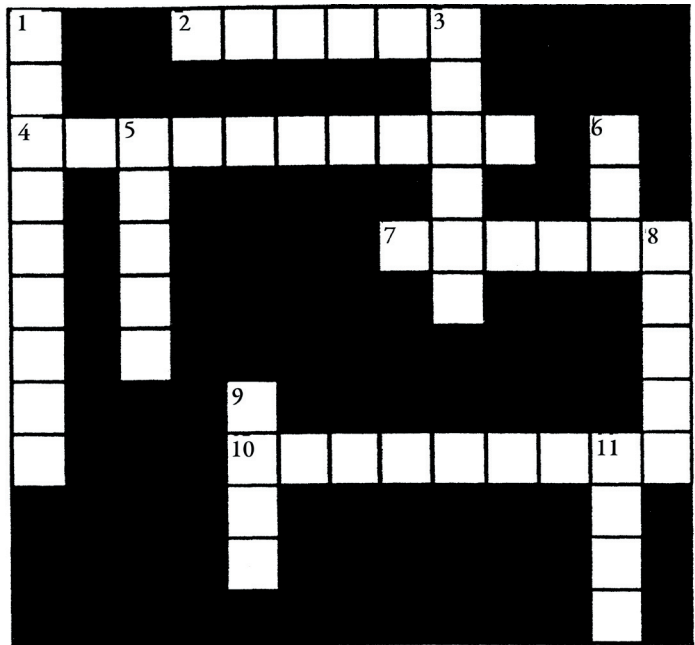

ANSWERS: 1. Gold 2. Spices 3. Silver 4. Tabernacle 5. Brass 6. Oil 7. Jewels 8. Skins 9. Wool 10. Offerings 11. Gold

Search Me...

Find the words hidden here.

- | | |
|-------------|------------|
| OFFERINGS | CHERUBIM |
| GOLD | CUBIT |
| SILVER | ALTAR |
| BRONZE | LAVAR |
| BLUE | MERCY SEAT |
| PURPLE | LAMPSTAND |
| SCARLET | ARK |
| LINEN | WORSHIP |
| YARN | GOAT HAIR |
| OLIVE OIL | RAM SKINS |
| SPICES | WOOL |
| ONYX | HIDES |
| JEWELS | WILLINGLY |
| TABERNACLE | CURTAINS |
| FURNISHINGS | COURTYARD |
| EPHOD | |



The Tabernacle Coverings

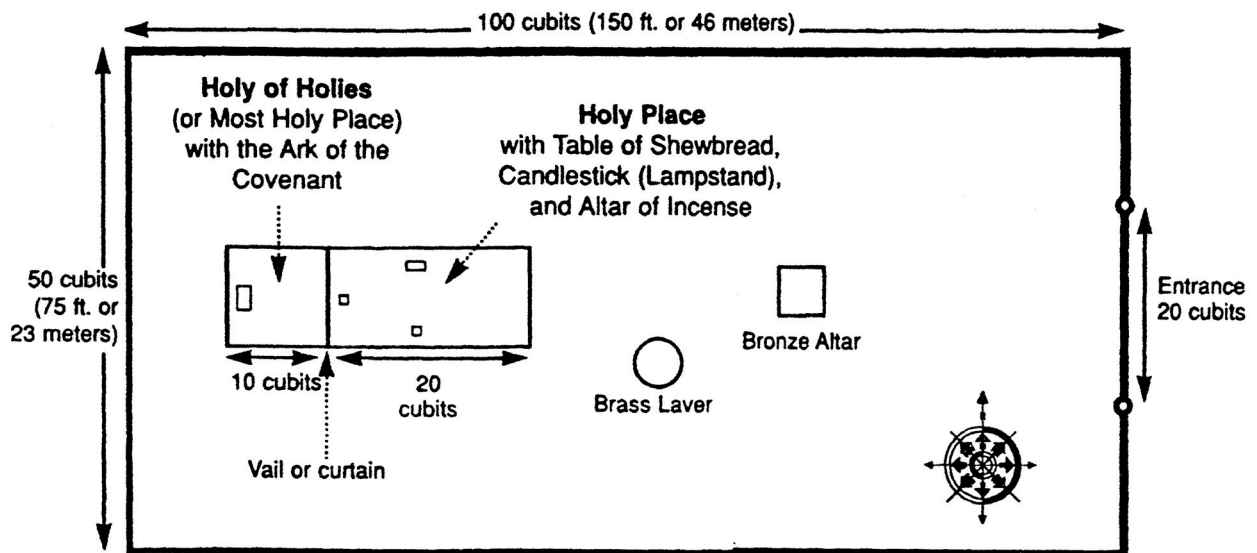
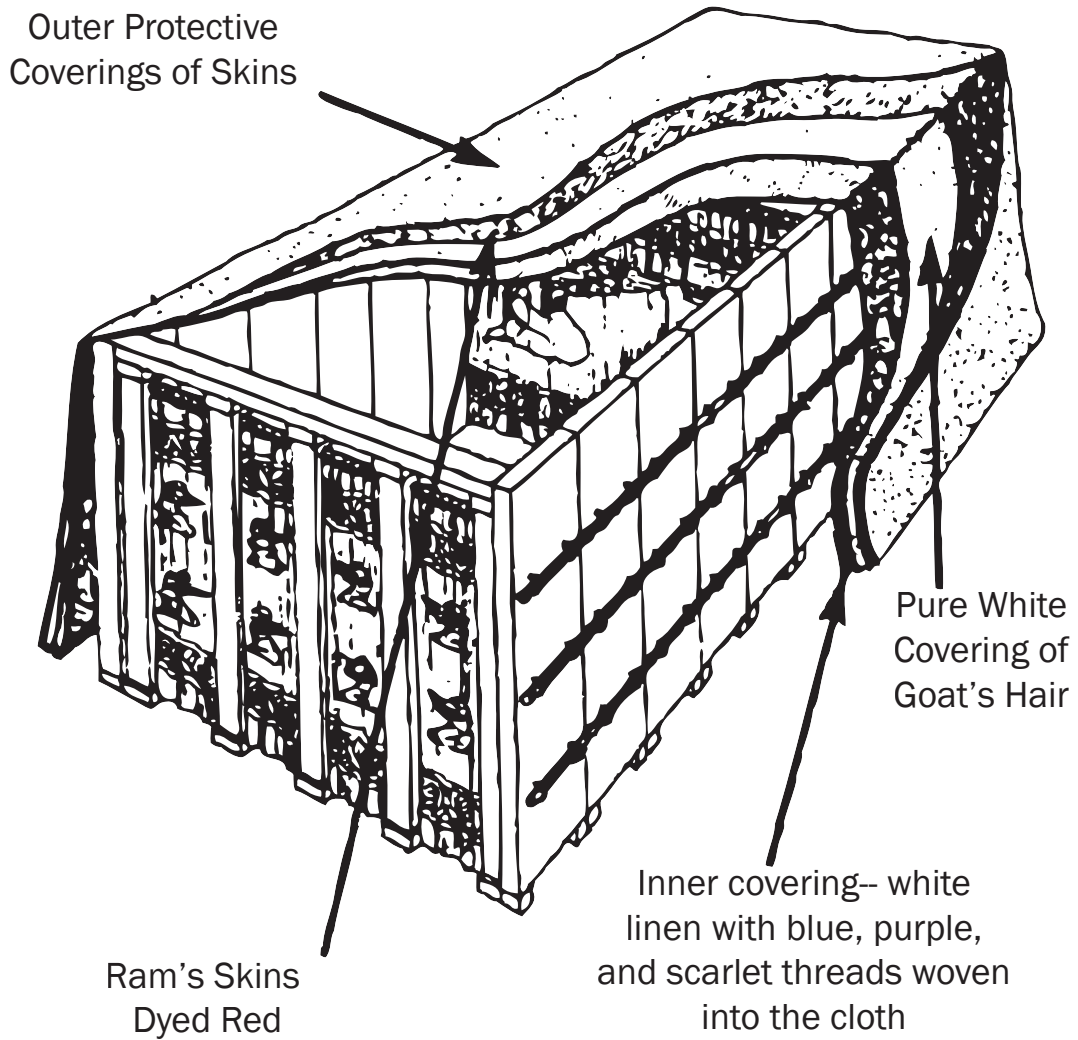

Word Search and Puzzle

Search Me...

Find the words hidden here.

- | | |
|---------------|----------------|
| ANOINTING OIL | LEVITES |
| BLUE | LIGHT |
| BRACELETS | LORDS OFFERING |
| BREASTPLATE | MANNER |
| CHILDREN | MOSES |
| COMMANDED | PRIEST |
| CONGREGATION | SACRIFICE |
| EARRINGS | SCARLET |
| FINE LINEN | SERVICE |
| HEART | SHITTIM WOOD |
| HOLY GARMENTS | SPICE |
| ISRAEL | SPIN |
| JEWELS | TABLETS |



Know What I Mean?

Match the word on the left with the description on the right.

- | | |
|--------------|---|
| Tabernacle | A living creature that was about to be slain for sin |
| Sin Offering | Amends for a wrong; to restore |
| Mediator | The tribe who took care of the Tabernacle |
| Levites | Jesus Christ |
| Bezaleel | The man who was a craftsman in metalwork and the art of weaving |
| Aholiah | The man who was to oversee the building of the Tabernacle |
| Lamb of God | The person who is the go-between of two parties at odds |
| Atonement | The movable "tent of meeting" |

Word Search and Puzzles

Search Me...

Find the words hidden here.

- | | |
|-------------|----------------|
| COURTYARD | ONE GATE |
| BASIN | JESUS CHRIST |
| MIRRORS | CUBIT |
| HIGH PRIEST | BRAZEN ALTAR |
| WHITE LINEN | ACACIA TREE |
| CURTAIN | MESSIAH |
| SILVER | JUDGEMENT |
| BRONZE | LAMB |
| BLUE | LAVER OF BRASS |
| PURPLE | EGYPT |
| SCARLET | WASH |



Know What I Mean?

Match the word on the left with the description on the right.

- | | |
|-----------|--|
| Gate | Judicial decision by a judge |
| Fence | Something laid over a thing for protection |
| Altar | Metal of copper and tin |
| Laver | An opening into an enclosure |
| Offering | Elevated structure on which to offer sacrifice |
| Bronze | To make clean |
| Cleanse | A large basin of water |
| Judgement | Something offered in worship |
| Covering | A barrier that marks a boundary |

What Did John See?

John 1:36

Use the code to find out what John saw.

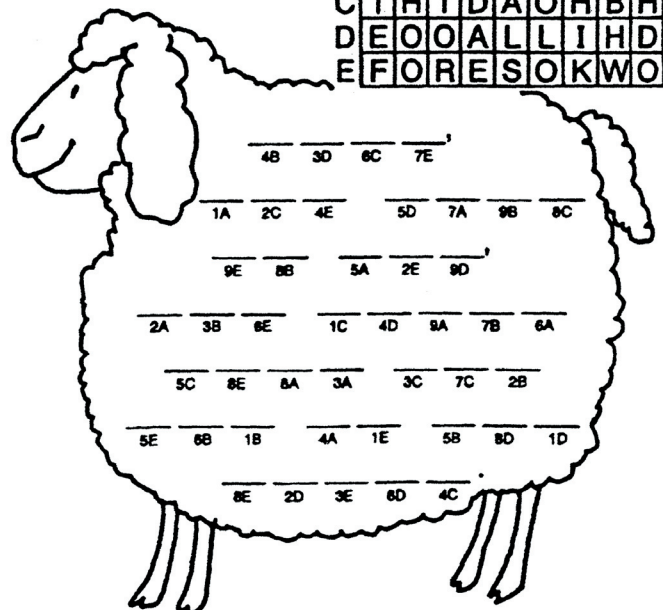

The Brazen Altar

Christians are told to present our bodies as a living sacrifice (Romans 12:1). God requires that He is first in our lives. He is to receive the best we can offer in time, energy and worship.

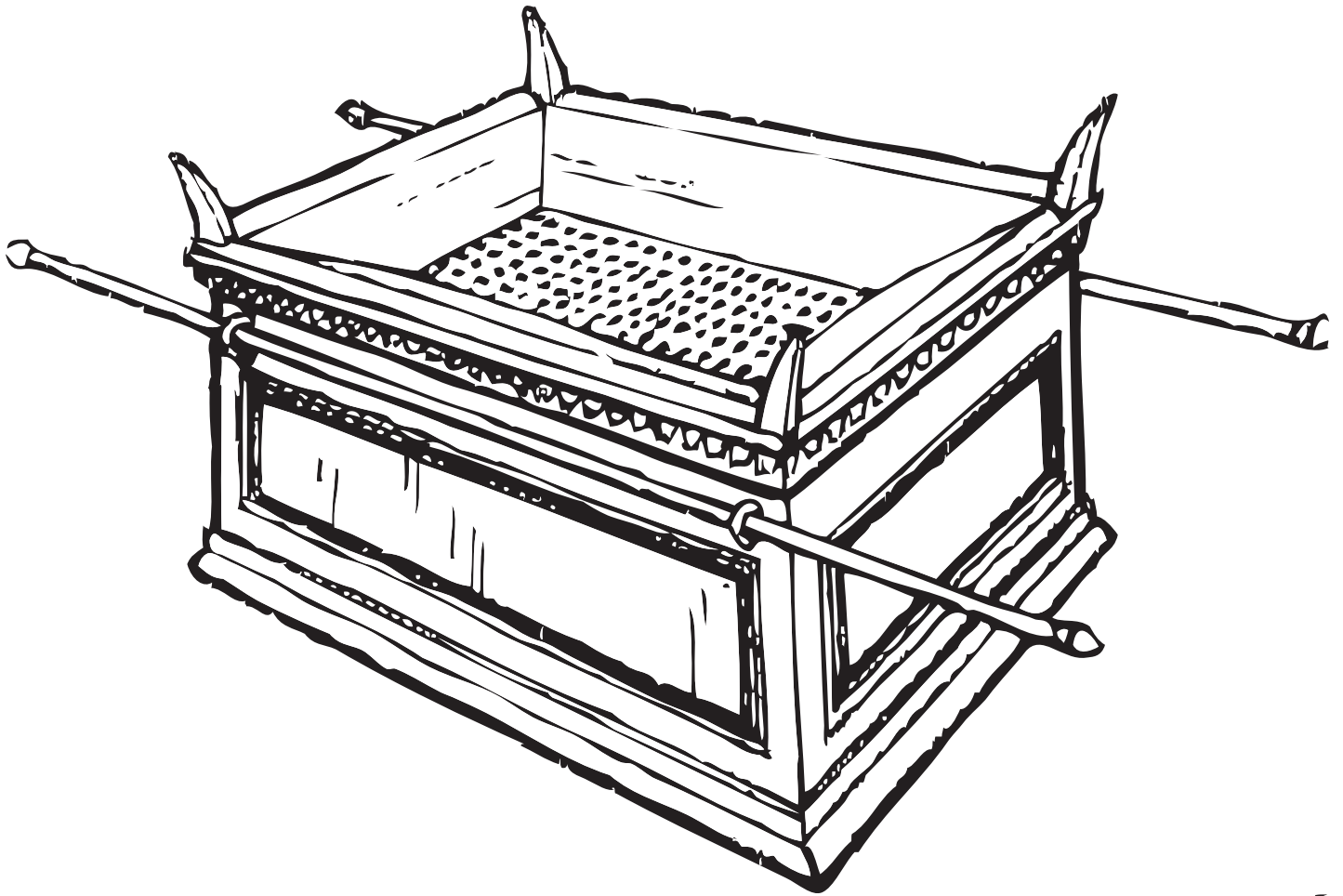

The Bronze Laver

After making the sacrifice, the priest washed himself at the brass laver. This washing purified the priest and prepared him to enter the Tabernacle. In Exodus 30:20, God says they must wash so that they do not die when they enter the Tabernacle.

The brazen laver was made from brass mirrors donated by the women of Israel. The Bible does not describe the laver completely, but perhaps it could be shined to have a shiny mirrored surface which would help the priest inspect himself to be sure he had washed thoroughly.



The Tabernacle Layout

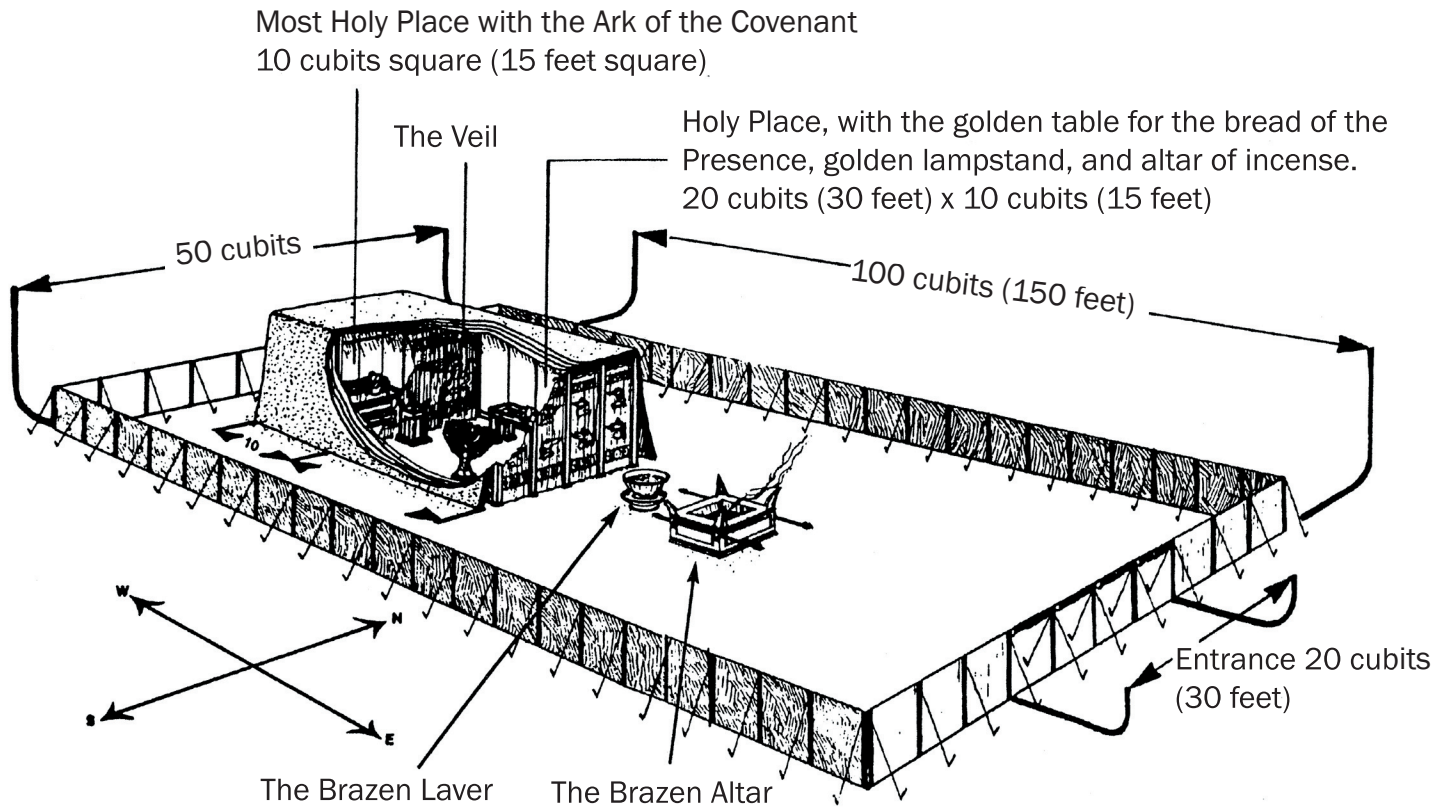

Christ is Seen in the Tabernacle

1. Christ is our _____ (John 1:29; 2Corinthians 5:21; Hebrews 10:9, 10, 13:10).
2. Christ _____ us from sin. (Ephesians 5:26-27; Hebrews 10:22; Titus 3:5).
3. Christ is the _____ of the _____ (John 8:12, 1:14, 12:46).
4. Christ is the _____ of _____ (John 3:32, 33, 35).
5. Christ is our _____ (I Timothy 2:5-6; Hebrews 7:25, Revelation 8:3-4).
6. Christ is the _____, _____ and _____. (John 14:6, Hebrews 10:19,20).
7. Christ's blood brought God's _____ (Ephesians 2:4, Hebrews 4:16, 10:19).
8. Christ is our _____ (Hebrews 2:17, Revelation 1:5,6).

Crossword and Puzzle

The Most Holy

Across:

- 1. They sat upon the Mercy Seat.
- 4. The wood used in building the Ark (2 words)
- 7. Aaron's staff
- 8. The 10 Commandments were written upon them.
- 10. Anything that prevents passage
- 12. Amends
- 13. Used to overlay the wood used in the Tabernacle.

Down:

- 2. There can be no atonement without the shedding of _____.
- 3. The food miraculously provided to Israel in the wilderness.
- 5. Only this person could go into the Holy of Holies on the Day of Atonement (2 words)
- 6. The Ark of the Covenant sat upon this; it was made of solid gold (2 words)
- 9. Blood on the Mercy Seat signified that the price for _____ had been paid.
- 11. To correct something.

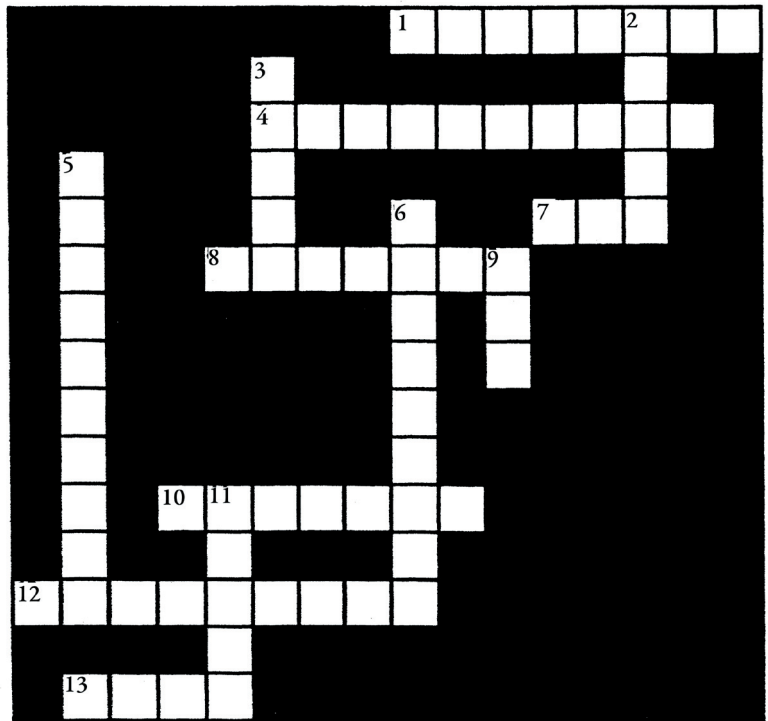

It's a Match!

At the bottom, identify the name of the Tabernacle furnishing with the letter that illustrates it.

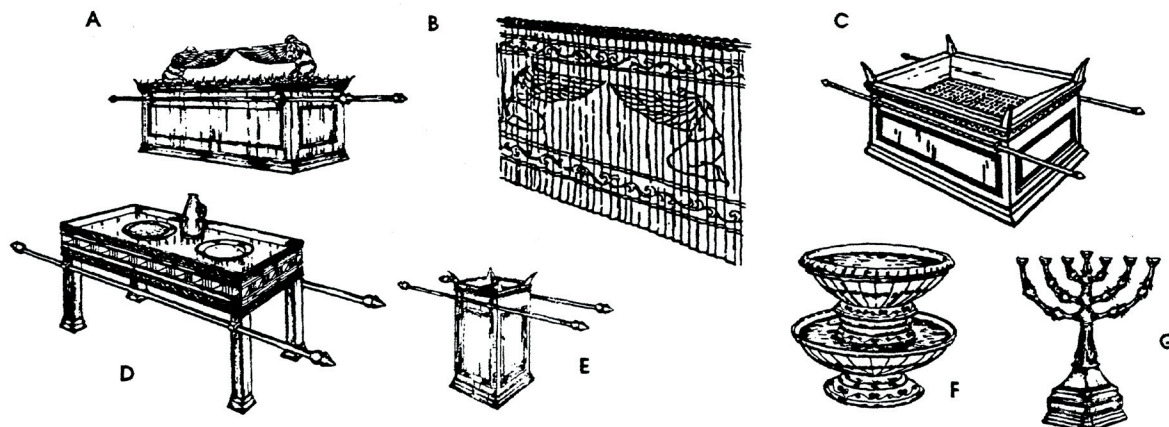

- 1. The Altar of Incense _____
- 2. The Table of Shewbread _____
- 3. The Golden Candlestick _____
- 4. The Veil _____
- 5. The Brass Laver _____
- 6. The Ark & the Mercy Seat _____
- 7. The Brazen Altar _____

ANSWERS: 1. Cherubim 2. Blood 3. Manna 4. Acacia Wood 5. High Priest 6. Mercy Seat 7. Rod 8. Tablets 9. Sin 10. Barrier 11. Amend 12. Atonement 13. Gold

The Tabernacle

God gave Moses specific instructions on how to build the place of worship. What was the place of worship called?

Below is an outline of the place of worship. Find the name of each of the specially marked places.

CODE: A B C D E F G H I J K L M N O P Q R S T U V W X Y Z
 Z Y X W V U T S R Q P O N M L K J I H G F E D C B A



G S V G Z Y V I M Z X O V

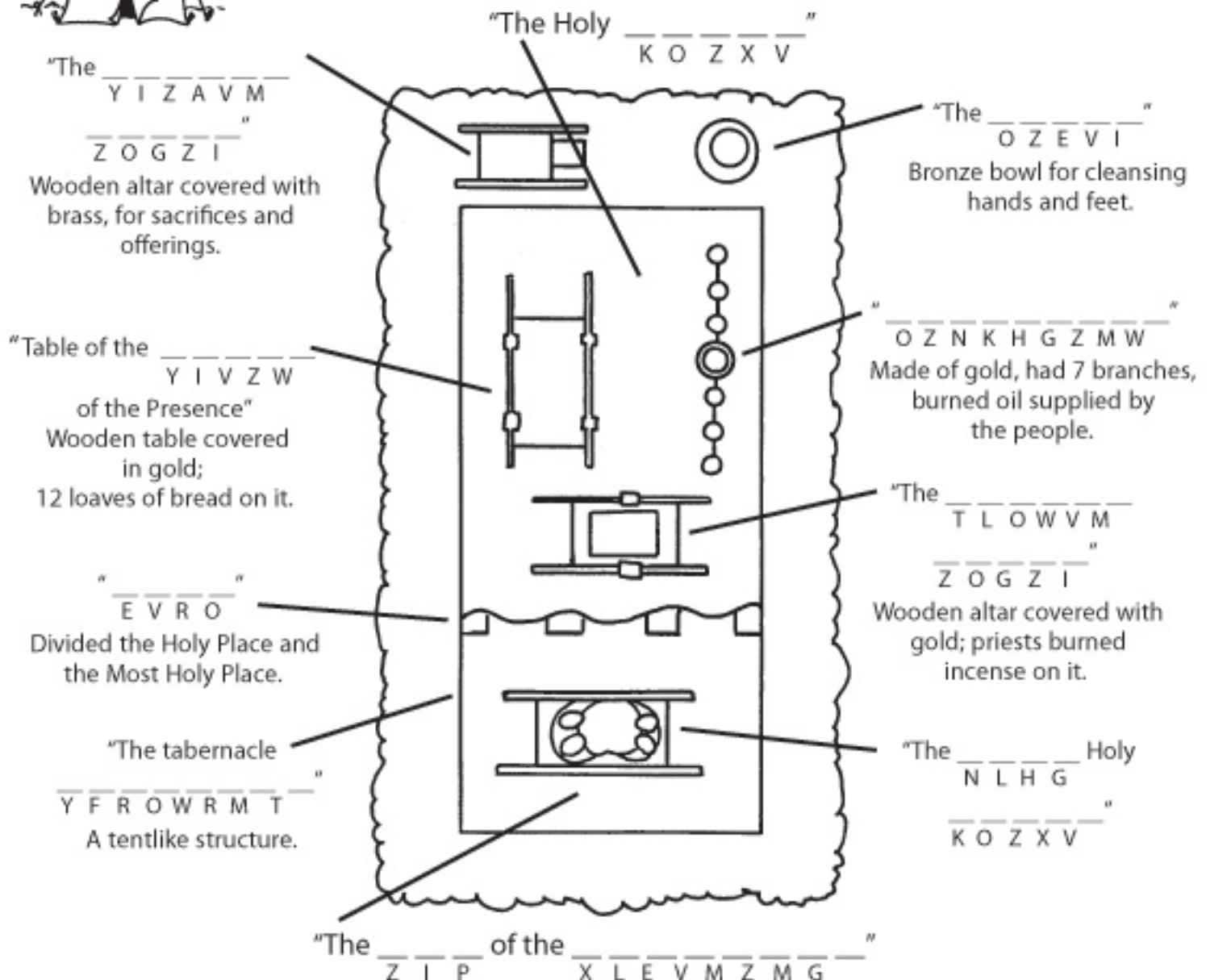

A wooden chest covered with gold inside and out. The lid was called the mercy seat. Two cherubim were on top. Inside were the stone tablets of the Law, a golden pot of manna and Aaron's rod.

The Golden Candlestick

This unique candlestick was beaten from a single piece of gold. Scripture says it was fueled by oil, not wax. It had lamps at the top of each branch. Trimming the lamp wicks was a very important job for the priest.

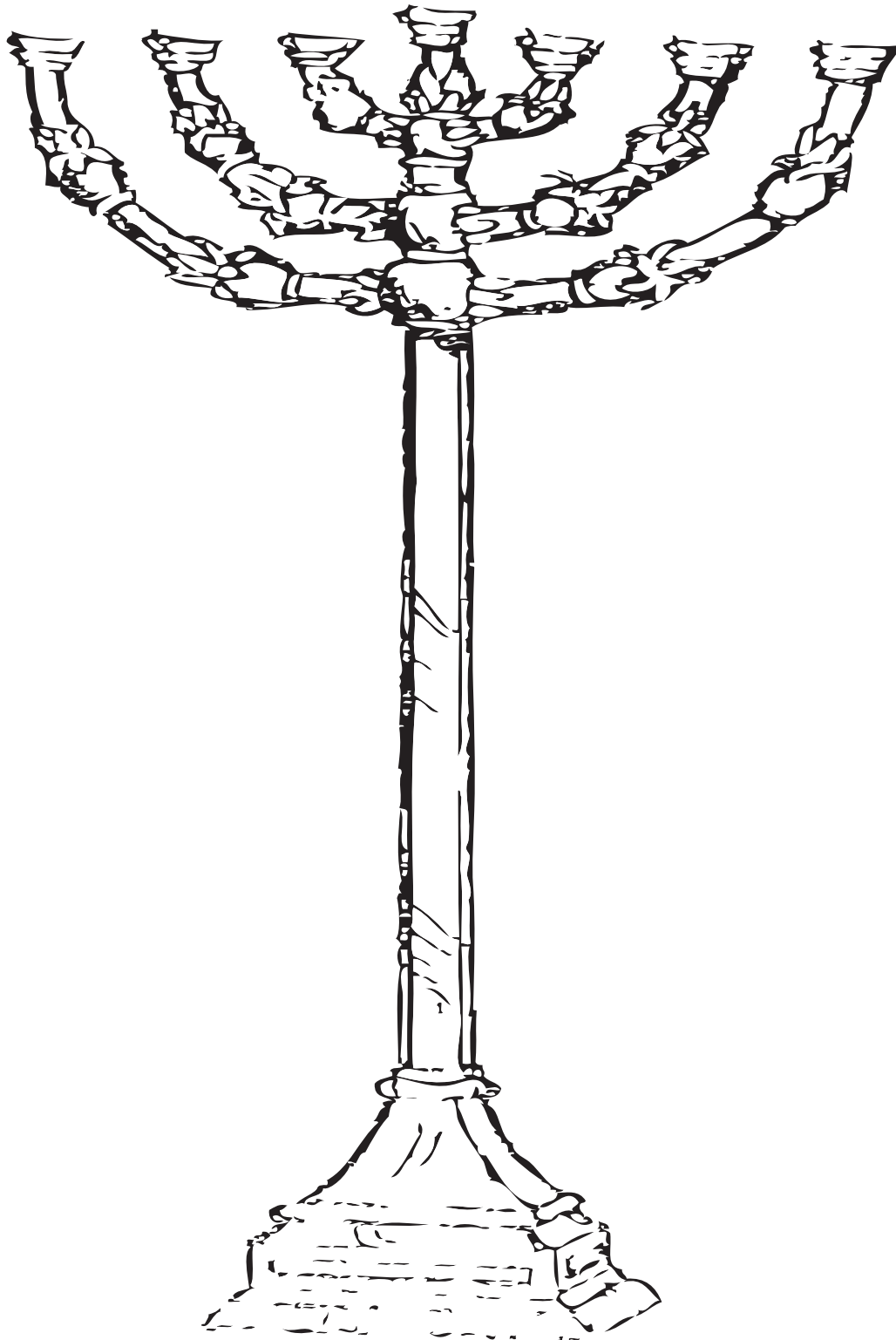

The Altar of Incense

Special incense was to be burned constantly on the altar of incense. It was a special sweet incense, a mixture of spices to be used only for the Tabernacle. None other was to be burned on the altar.

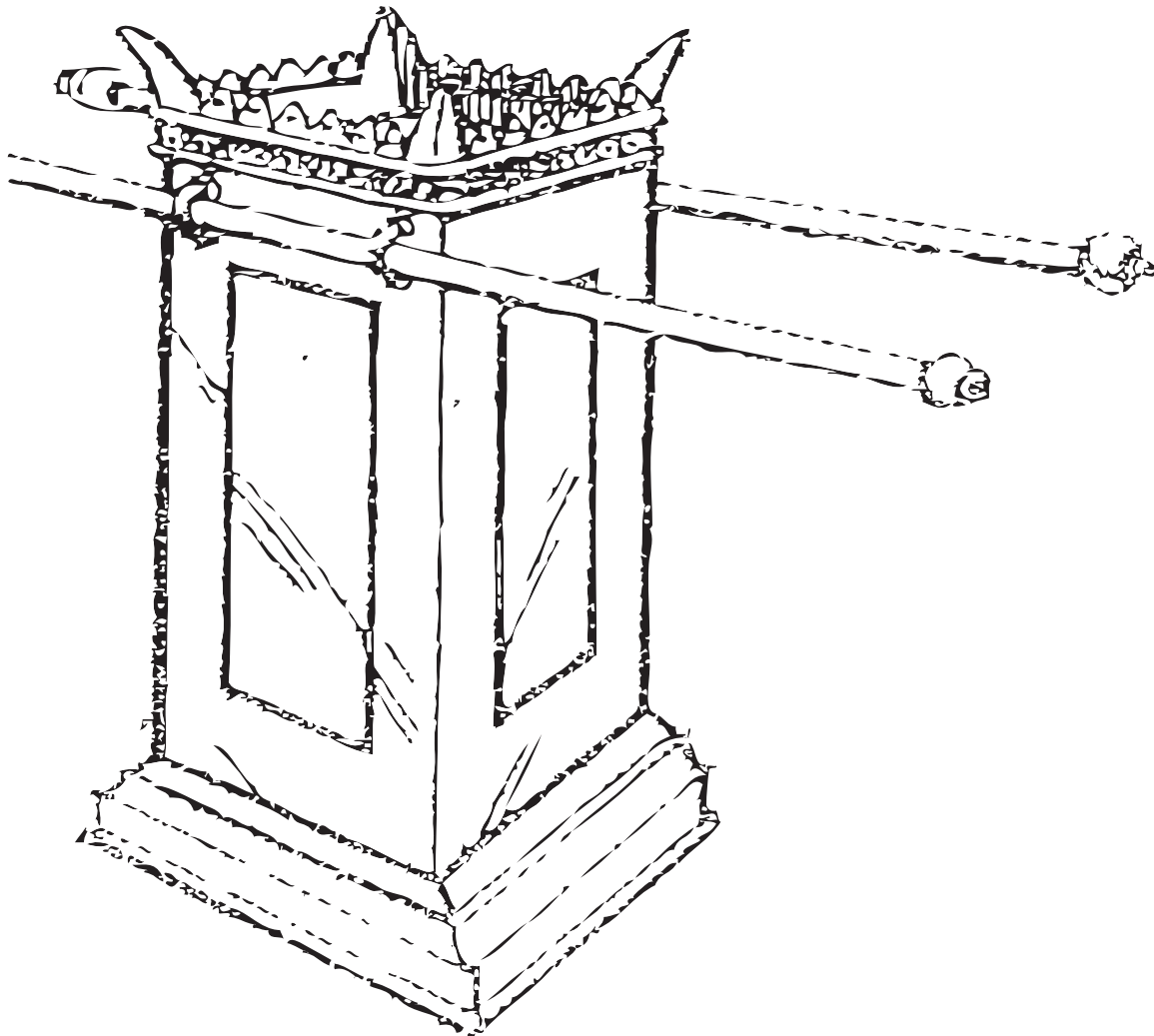

The Table of Shewbread

The bread was eaten by Aaron and his sons and was replaced every week on the Sabbath. The table with the loaves was a continual reminder of the everlasting promises, the covenant between God and the children of Israel, and a memorial of God's provision of food.

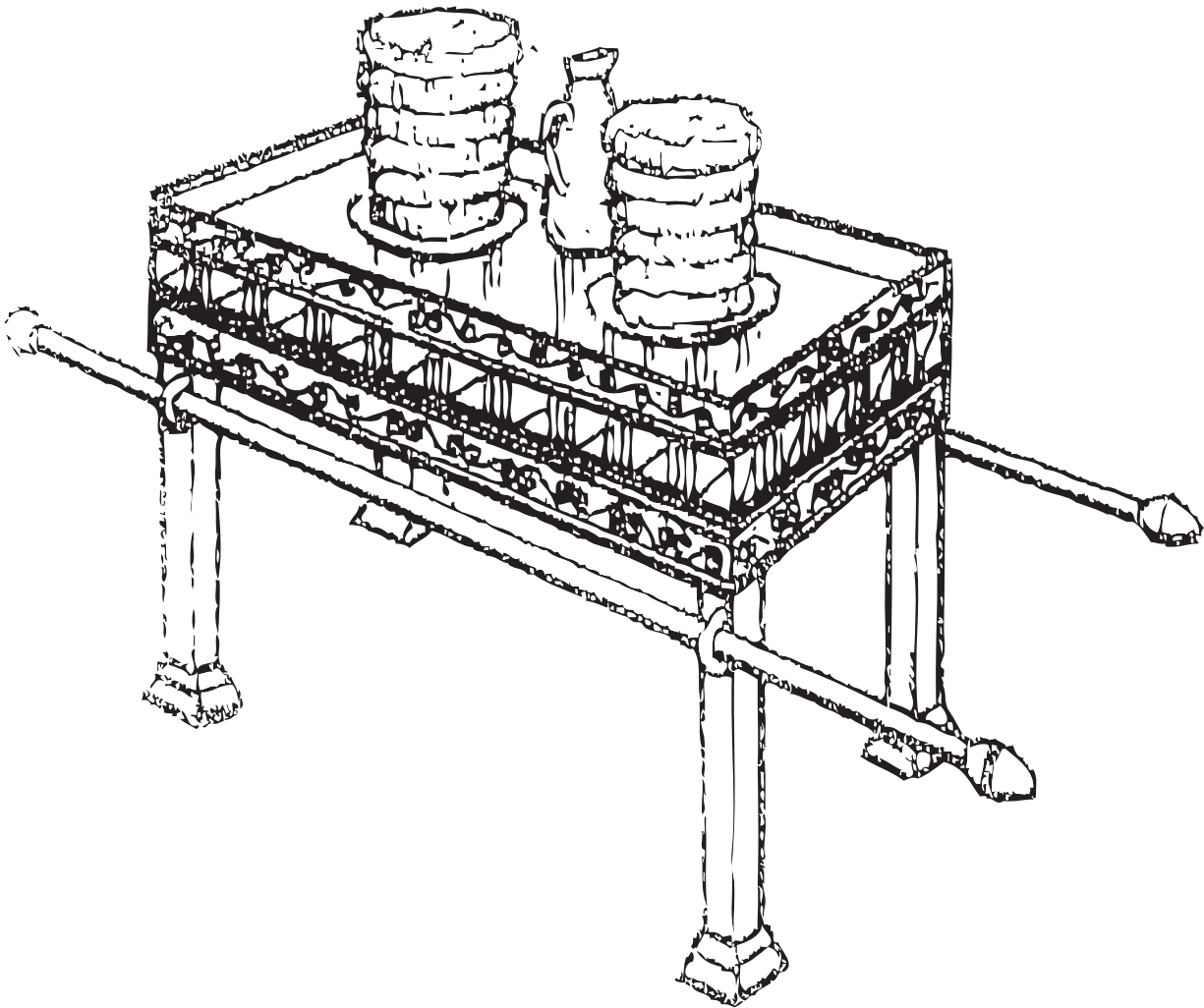

The Veil

The veil was a heavy woven cloth stretching for ten cubits (15 feet or 4.5 meters). There was no opening in the middle. The priest had to go around the side to enter the most Holy Place. When the Temple was built the veil followed a similar design.

The Temple veil was torn from the top to the bottom when Jesus died. Every believer can now approach God through Jesus.

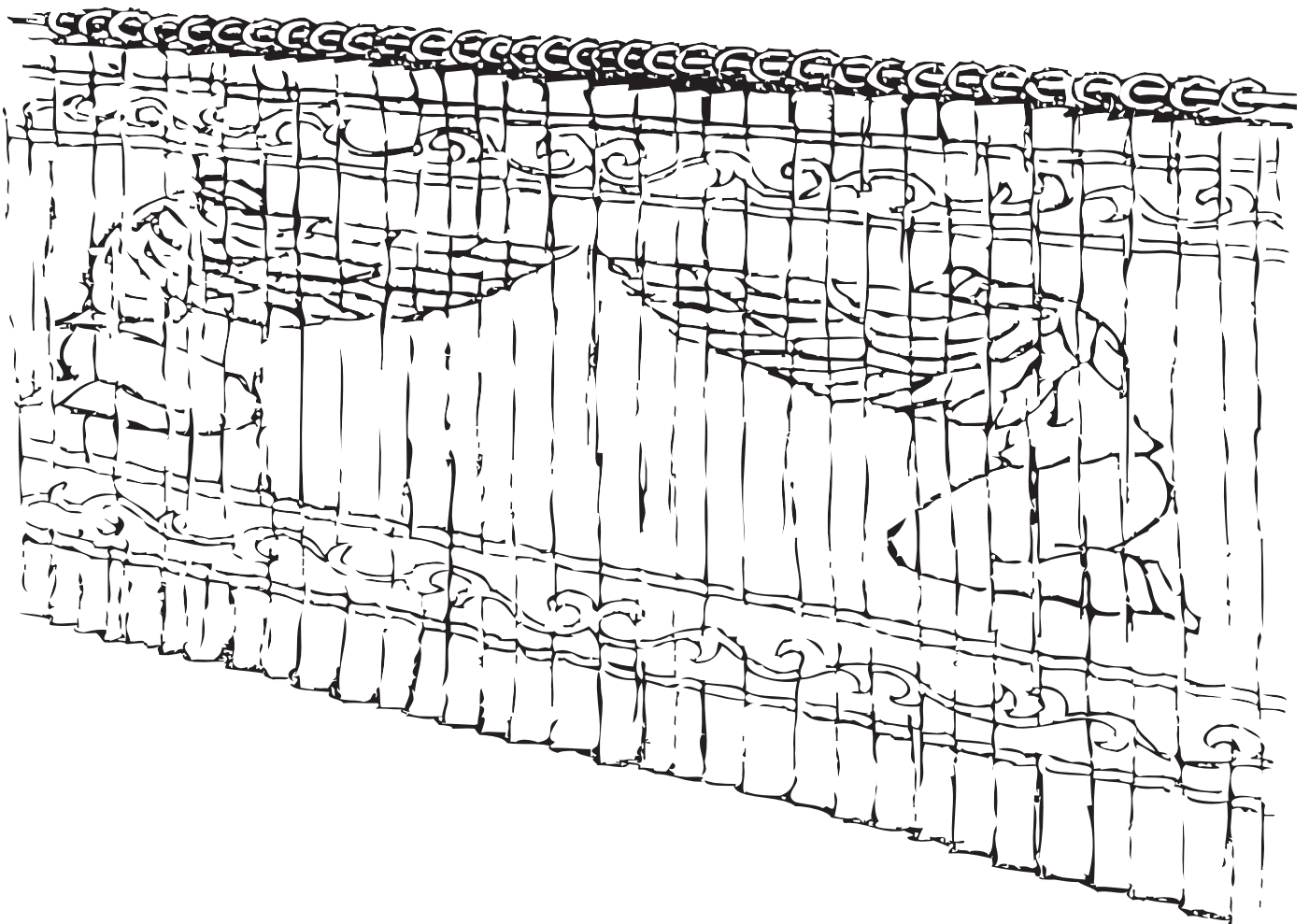

The Ark of the Covenant & the Mercy Seat

The Ark more clearly reflects Jesus Christ than any other thing in the Bible.

The central focus of the entire Tabernacle was the Holy of Holies where God spoke to the high priest above the Mercy Seat, the area where the winged cherubim face each other.

The layout of the Tabernacle along with the steps of sacrifice, cleansing and remembering God's promises are all designed to bring sinful mankind to a loving and holy God.

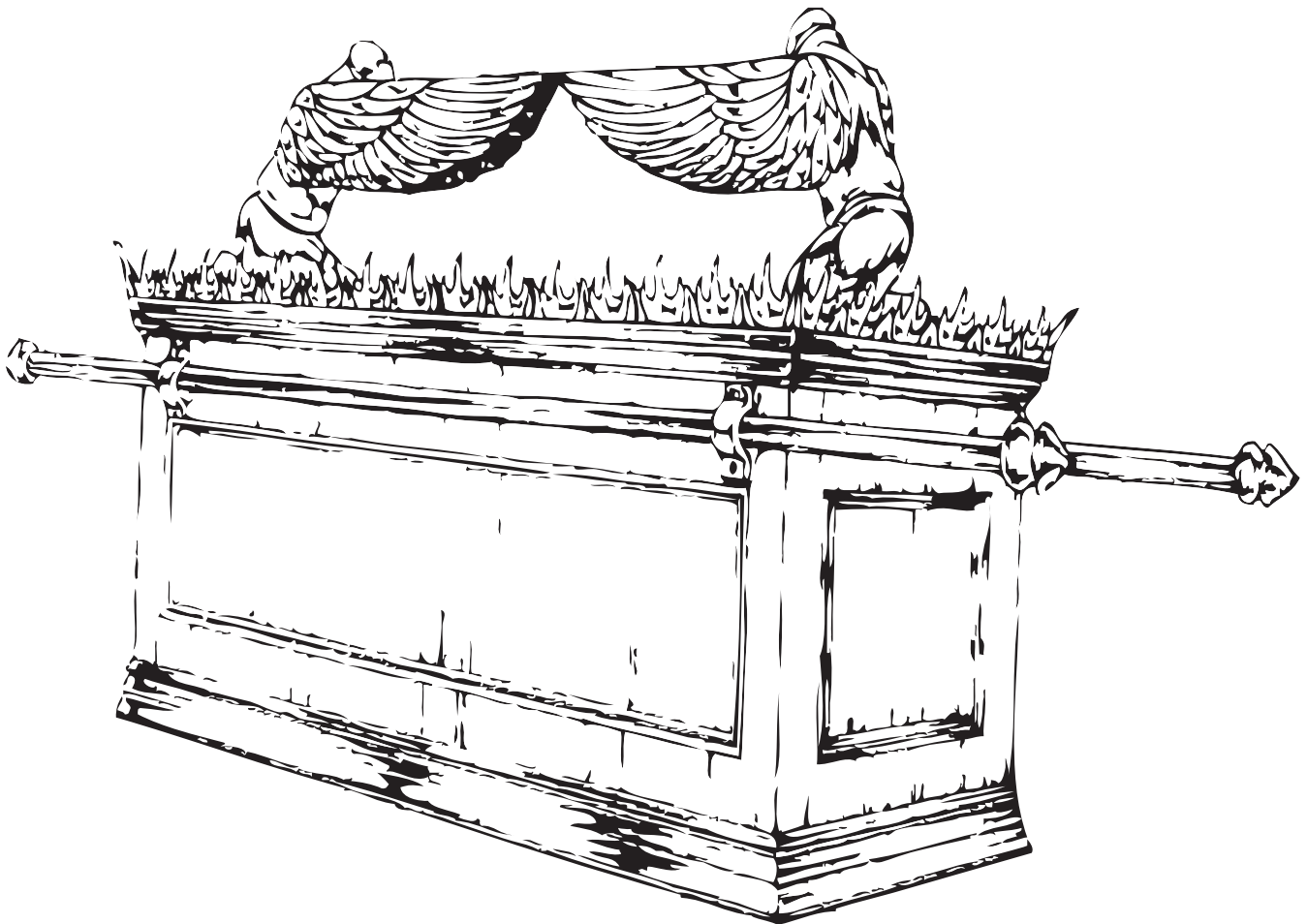

Mirror, Mirror...

We can gain deeper insight when we see the reflections of the Tabernacle worship in God’s great plan of salvation through Jesus Christ.

Israel Communed with God through the Tabernacle

Christians Commune with God through Jesus



1. Brazen Altar for sacrifices
2. Laver of Brass for washing
3. Candlestick/Lampstand
4. Table of Shewbread
5. Altar of Incense
- 6-7. Through the gate and into the enclosure of the Tabernacle
8. Priests and the priesthood

1. Christ’s sacrifice
2. Cleansed by the blood and water
3. Enlightened by the Holy Spirit
4. Fed by the living Word
5. Prayer, intercession, communication
- 6-7. Entering God’s presence through Christ – the “Gate”, our High Priest
8. Service to God and others

Search Me...

Find the words hidden here.

MEDIATOR
PRIESTS
AARON
ATONEMENT
CEREMONY
WHITE LINEN
JUDGES
LEVITES

MUSICIANS
GATE KEEPERS
ASSIST
SACRIFICES
BREASTPLATE
ONYX
POMEGRANATES
HOLINESS



Complete the Sentence

1. A _____ is someone who intercedes as a go-between.
2. In the Tabernacle the _____ was the only one to enter into the Holy of Holies.
3. _____ was the first high priest.
4. There were _____ precious stones set into the breastplate of the high priest.
5. We are to be the _____, Jesus Christ is the _____.

ANSWERS: 1. mediator 2. high priest 3. Aaron 4. twelve 5. tabernacle, High Priest

Priest

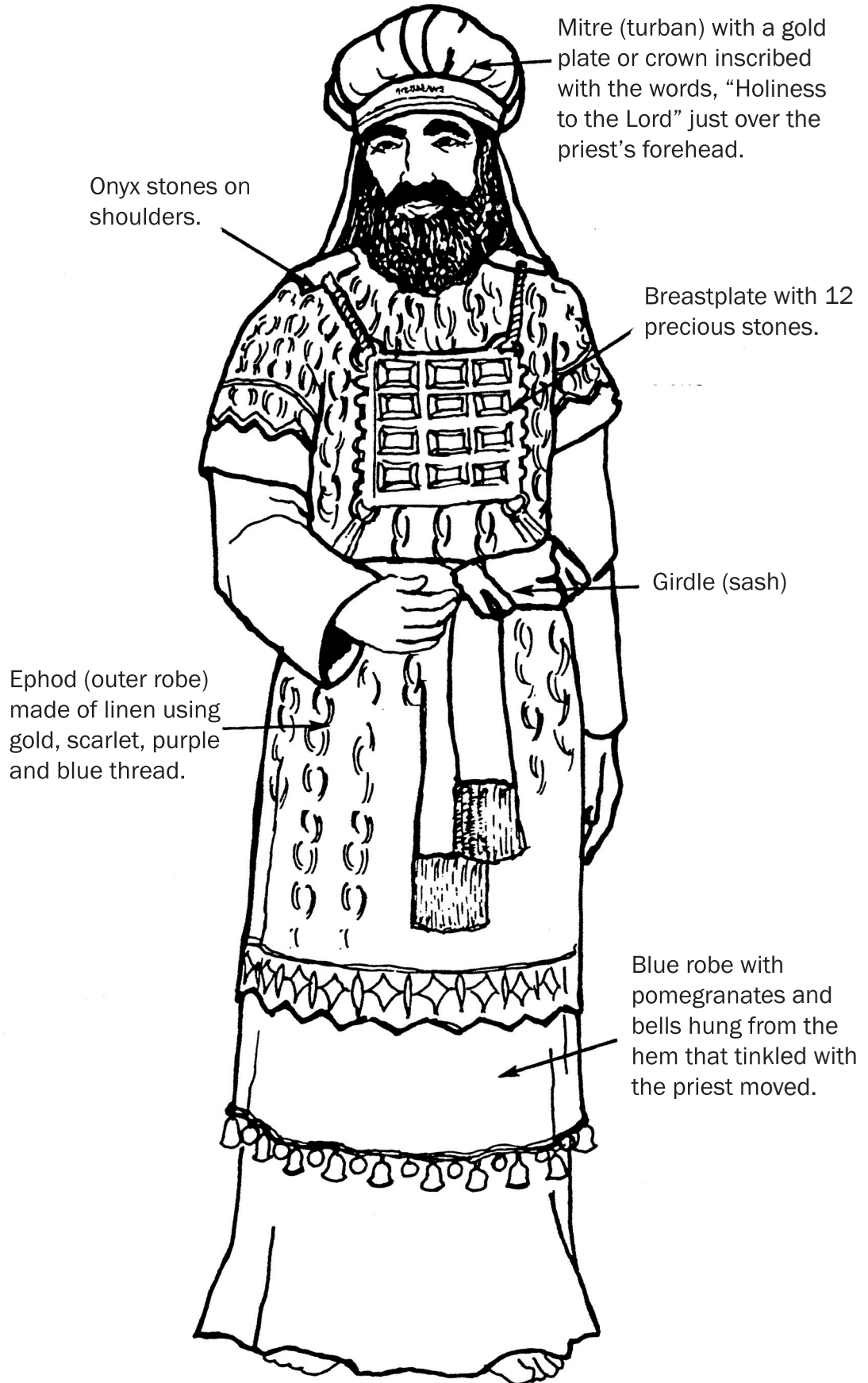

The High Priest's Breastplate

The twelve tribes of Israel and descriptions of the twelve stones.
Color in stones lightly with crayons.

ZEBULUN Beryl (light red)	ISSACHAR Topaz (yellow)	JUDAH Ruby (dark red)
GAD Diamond (gray)	SIMEON Sapphire (blue)	REUBEN Emerald (green)
BENJAMIN Amethyst (purple)	MANASSEH Agate (gray-striped)	EPHRAIM Jacinth (orange)
NAPHTALI Jasper (brown)	ASHER Onyx (black)	DAN Chrysolite (blue-green)

Did You Know...

The stones on the breastplate bore the names of the twelve tribes of Israel. They were not exactly the same as the twelve sons of Jacob. Neither Levi nor Joseph had a tribe named for them. Two tribes were named for Joseph's two sons, Manasseh and Ephraim, bringing the total tribes to 12, the same as the number of Jacob's sons.

The breastplate bearing the precious stones was worn over the High priest's heart.

Onyx stones have a translucent and opaque marbled quality and come in shades of white, cream, and natural earth tones.

Solomon Builds the Temple

The temple was twice as large as the Tabernacle it replaced.
It was generally similar, but much more splendid.

Begin at the ★.
Go around clockwise.
Write down every other vowel on the blanks.

God ch__s__ King Solomon t__ b__ld __
t__mpl__ __n J__r__s__l__m.

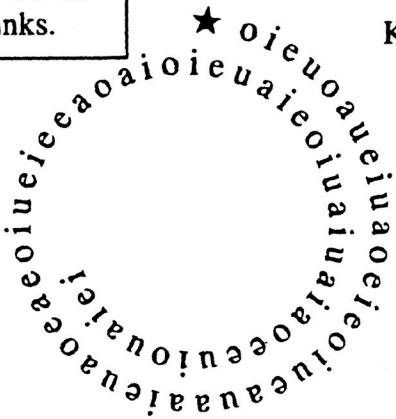

King David h__d b__n g__v__n th__
pl__ns __nd st__r__d up m__t__r__ls,
b__t God d__d n__t l__t h__m
b__ld __t.

Use this code to complete the story.

- = 90 feet = overlaid = 45 feet = large = front = inside
- = 7 years = carved = more = front = twice = gold
- = 30 feet = 15 feet = wide

It took _____ to build. It was _____ long, _____ wide, and _____ high. There was a porch across the _____ as _____ as the temple. It came out _____ in _____. The _____ was lined with cedar wood, _____ with flowers and gourds and _____ with _____. It was _____ as _____ as the tabernacle it replaced. It was far _____ splendid.

I Accept

God had accepted Solomon's prayer. God spoke to Solomon at night. He told him that if he followed God's ways and walked before God as his father David had done, God would be

Write every other letter on the lines. Begin with the star and go clockwise.

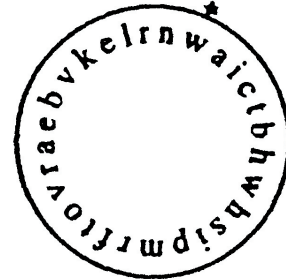

The Dedication

When the Temple was finished the people rejoiced. They were "glad in heart."

Find these things in the picture below. Circle them.

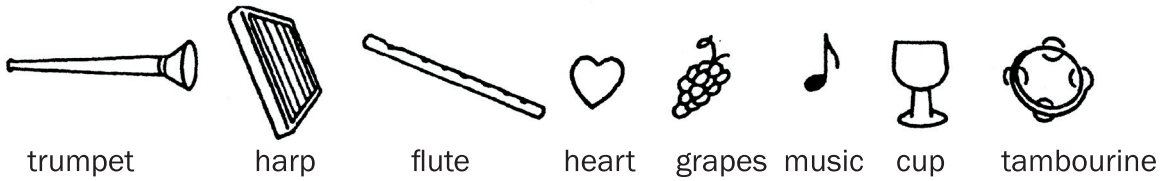

Search Me...

Find the words hidden here.

- | | |
|-------------|----------|
| MAGNIFICENT | TEMPLE |
| GLORY | ISAIAH |
| HOLY | VISION |
| UZZIAH | THRONE |
| KING | ROBE |
| IDOL | SERAPHIM |
| WORSHIP | SINNER |
| RIGHTEOUS | MAJESTY |
| PROUD | SMOKE |
| INCENSE | COAL |
| PUNISHMENT | |



Use the picture graph to find the answers.



☺	A	E	I	N	S	W
🕒	B	F	K	O	T	X
🌸	C	G	L	P	U	Y
🍇	D	H	M	R	V	Z
	🕯	🌿	👉	❤	🏠	🍷

After Uzziah had

his

led to his

He with the

God

out on his

King Uzziah

Uzziah (U-ZI-a) became a king over Judah when he was 16. He did what was right before the Lord, just as his father Amaziah (am-a-ZI-a) had done. But he did something wrong later.

Uzziah became well-known because of his military victories. But as he became more powerful his pride got the best of him.

Uzziah forgot who really was the strength behind his kingdom. He allowed the people to turn to idol worship.

His disrespect and lack of reverence for God led him to a tragic end.

Send Me!

God called Isaiah to speak God's message to the people.

Fit the words from this list into the crossword puzzle. Then copy the correct words from the puzzle into the story to find out more about Isaiah.

- God
- hot
- year
- LORD
- send
- robe
- lips
- holy
- glory
- shook
- guilt
- smoke
- throne
- vision
- Uzziah
- became
- seraph
- Isaiah
- temple
- beings
- wearing
- seraphs
- heavenly
- Almighty
- doorpost
- uncleanness

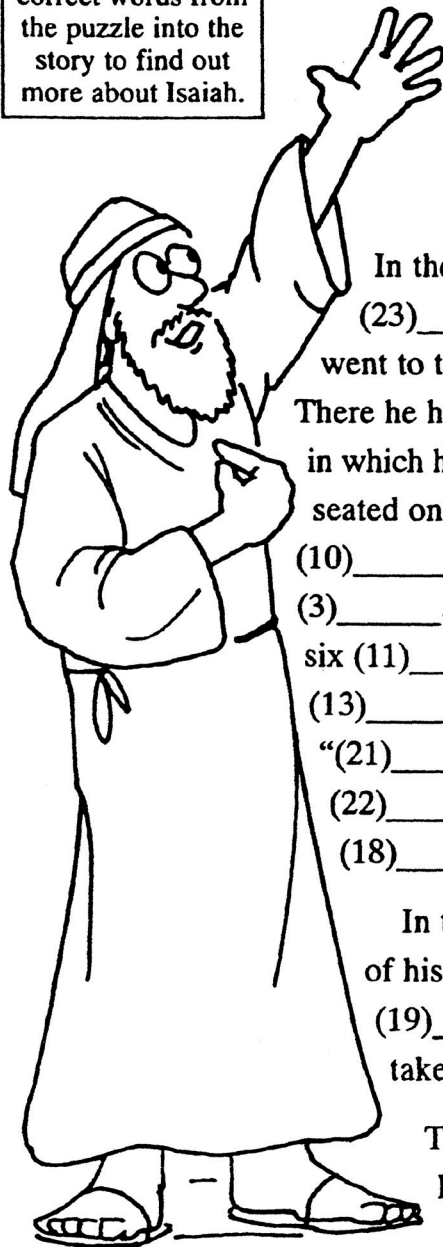
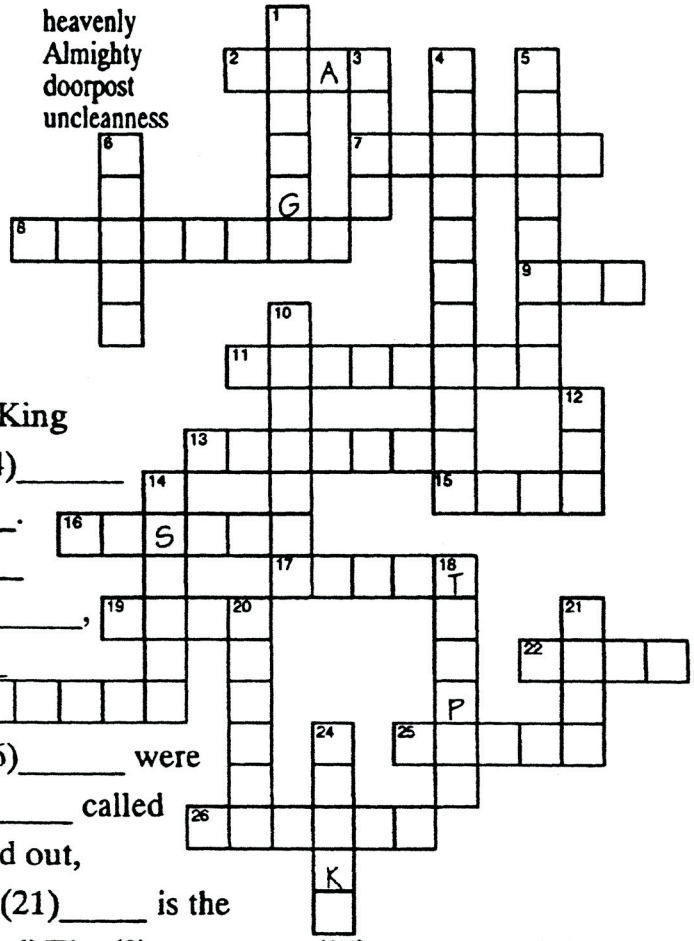

In the (2) _____ that King
 (23) _____ died, (14) _____
 went to the (18) _____.
 There he had a (16) _____
 in which he saw the (22) _____,
 seated on a (26) _____
 (10) _____ a _____
 (3) _____. Above the (26) _____ were
 six (11) _____ (1) _____ called
 (13) _____ who called out,
 “(21) _____, (21) _____ (21) _____ is the
 (22) _____ (5) _____.” The (8) _____ (24) _____ and the
 (18) _____ filled with (6) _____.

In the presence of God's (25) _____, (14) _____ became aware
 of his (4) _____. One (20) _____ touched Isaiah's
 (19) _____ with a (9) _____ coal and said, “Your (17) _____ is
 taken away.”

Then (12) _____ said, “Whom shall I (15) _____?”
 Isaiah said, “(15) _____ me.”

Christ Dwells Among Us

“And the Word became flesh and dwelt among us, and we beheld His glory, they glory as of the only begotten of the Father, full of grace and truth.” John 1:14

Look up the following scriptures and write them down.

1. 2 Corinthians 5:1 _____

2. Galatians 2:20 _____

3. Colossian 1: 27 _____

Offerings for the Lord

Micah 6:6-8

“And what does the Lord require of you?”

Write the first letter of each picture on the line.



“To _____ and



to _____

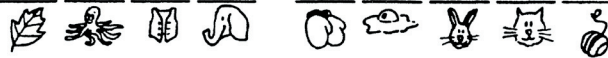

and to _____

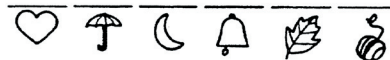
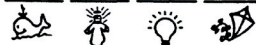

with



A	B	C	D	E	F	G	H	I	J	K	L	M	N	O	P	R	S	T	U	V	W	X	Y	Z	
Z	Y	X	W	V	U	T	S	R	Q	P	O	N	M	L	K	J	I	H	G	F	E	D	C	B	A

“With what shall I come before the Lord and

_____?”